

Article number: 0101095
 Description: Retaining ring A 95 DIN 471
 Spring steel
 Note: Fitted with ZGA pilers

Measures

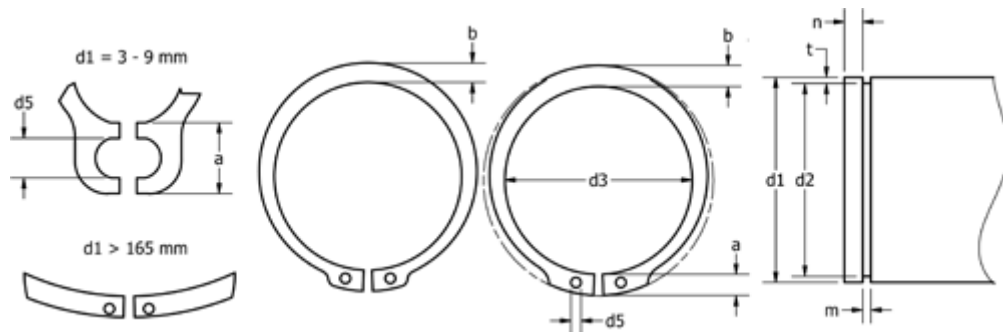

a max	= 9.4	FN kN	= 85.0	s	= 3.00
AN mm ²	= 513.0	FRg kN	= 29.20	t	= 1.75
b	= 8.6	FR kN	= 212.00	tol	= -0.35
d1	= 95	g	= 3.5	tol	= -0.08
d2	= 91.5	K kN-mm	= 400.00	tol	= +0,54-1,30
d3	= 89.5	m min	= 3.15	Tong	= ZGA-4
d5 min	= 3.5	n abl x 1000	= 5.0	Weight kg/1000	= 49.000
Description	= A95	Nominal drive	= 5.3		